

Specifications

Nominal Voltage	2V	
Nominal Capacity (10HR)	1200AH	
Dimension	Length	475mm (18.70 inches)
	Width	175mm (6.89 inches)
	Height	328mm (12.91 inches)
	Total Height (with Terminal)	350mm (13.78 inches)
	Approximate Weight	65.8 kg (145.1 lbs)
Battery Type	Valve Regulated Lead-Acid Battery, AGM Design	
Terminal Type	IT	
Rated Capacity	1280.0AH	(20hr, 1.80V/cell, 25°C/77°F)
	1200.0AH	(10hr, 1.80V/cell, 25°C/77°F)
	1065.0AH	(5hr, 1.75V/cell, 25°C/77°F)
	926.4AH	(3hr, 1.75V/cell, 25°C/77°F)
	720.8AH	(1hr, 1.60V/cell, 25°C/77°F)
Max. Discharge Current	9600A	
Internal Resistance	0.4mΩ	
Operating Temp. Range	Discharge:	-15°C (5°F)~50°C (122°F)
	Charge:	0°C (32°F)~40°C (104°F)
	Storage:	-15°C (5°F)~40°C (104°F)
Nominal Operating Temp. Range	25±3°C (77±5°F)	
Container Material	ABS (Option: 94-HB & 94-V0 flame retardant case)	
Capacity affected by Temperature	40°C (104°F)	103%
	25°C (77°F)	100%
	0°C (32°F)	86%
Self Discharge	SigmasTek SPL series batteries may be stored for up to 6 months at 25°C (77°F) and then a freshening charge is recommended. For higher temperatures the time interval will be shorter.	



Applications

- Tele - communication central station (wired or cellular)
- Military communication
- Data and television signal transmission
- UPS
- EPS



Constant Current Discharge (Amperes Per Battery) at 25°C (77°F)

F.V. (V/cell) \ Discharge Time	30min	45min	1h	2h	3h	4h	5h	6h	8h	10h	20h
1.60V	1164.7	888.0	720.8	444.0	331.2	266.2	224.5	194.4	154.5	126.2	66.2
1.65V	1126.1	864.8	704.2	435.6	325.6	262.5	221.3	191.8	152.3	124.4	65.7
1.70V	1073.5	828.7	679.8	421.8	318.4	257.0	216.6	188.5	150.0	123.0	65.0
1.75V	1023.1	798.6	656.7	405.6	308.8	251.5	213.0	185.2	147.5	121.6	64.3
1.80V	966.1	759.5	629.4	390.0	298.8	243.3	206.6	180.9	144.6	120.0	64.0
1.85V	900.4	721.9	601.9	373.2	284.8	232.9	198.3	173.2	138.6	115.6	61.8

Constant Power Discharge (Watts Per Cell) at 25°C (77°F)

F.V. (V/cell) \ Discharge Time	30min	45min	1h	2h	3h	4h	5h	6h	8h	10h	20h
1.60V	2134.8	1649.5	1355.8	843.6	634.0	512.5	434.2	378.5	303.3	249.4	131.0
1.65V	2085.0	1621.5	1333.8	832.8	626.5	507.6	429.8	374.5	299.5	246.3	130.2
1.70V	2002.6	1562.6	1294.9	809.9	615.4	498.7	422.2	369.3	295.8	243.8	129.1
1.75V	1924.8	1516.4	1257.7	782.0	599.1	490.0	416.3	363.4	291.1	241.1	127.7
1.80V	1831.5	1450.7	1210.7	755.0	581.2	475.5	405.2	356.1	286.1	238.3	127.3
1.85V	1720.8	1388.0	1164.3	725.9	556.6	456.7	390.6	342.2	275.0	229.8	123.1

Dimensions

IT Terminal

Unit: mm (inches)

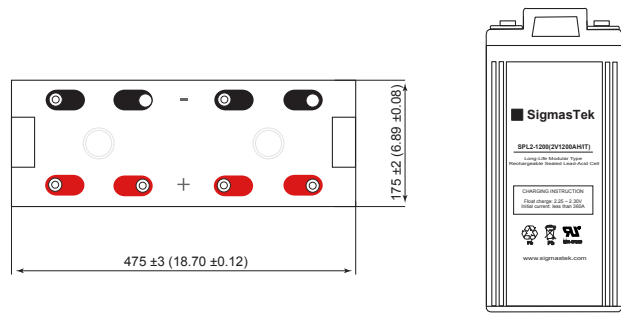
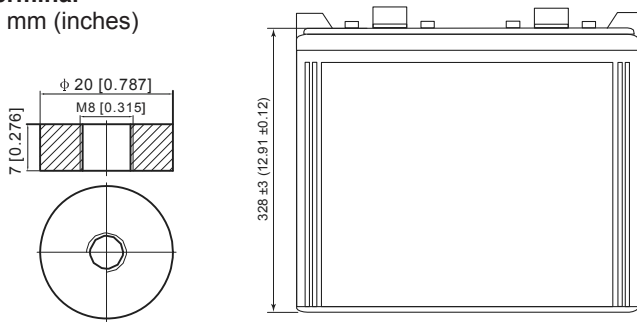

Self Discharge Characteristics

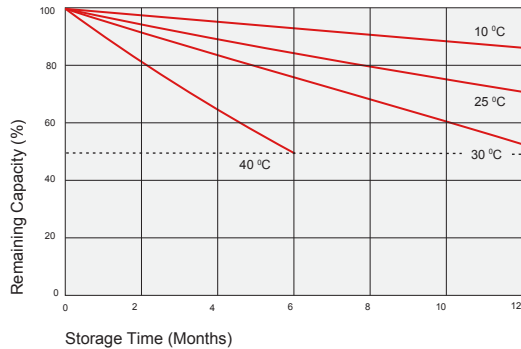

Discharge Characteristics

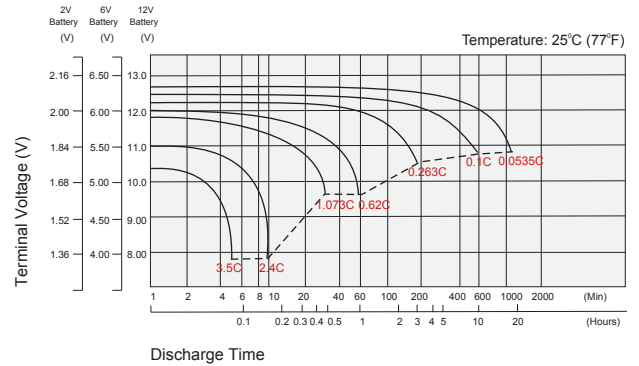

Float Charging Characteristics

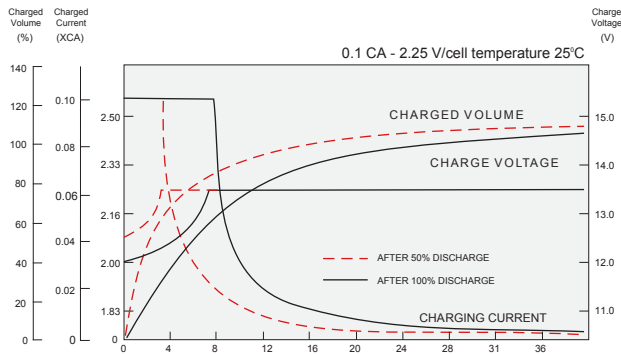

Temperature Effects in Relation to Battery Capacity

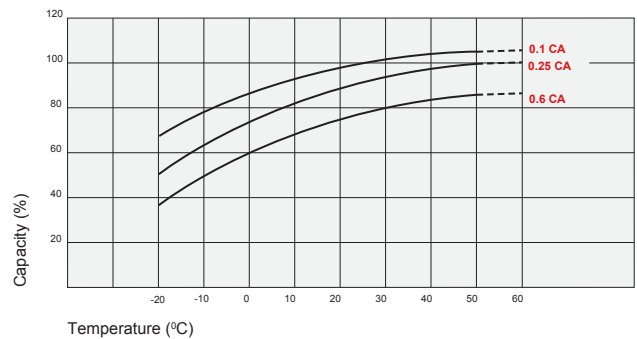

Temperature Effects on Long Term Float Life

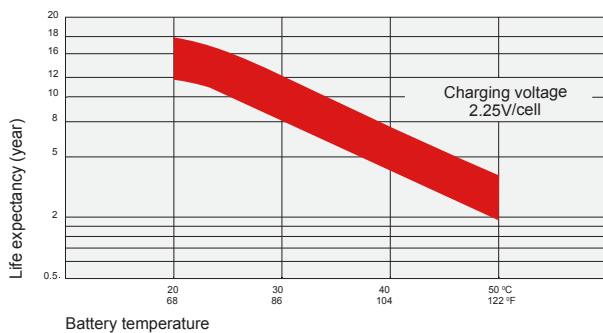

Contact Information

SigmasTek
7651 W 100th Place
Bridgeview, IL 60455, USA

T: (888) 988-8290
www.sigmastek.com
order@sigmastek.com